

Barras de refuerzo y pinzas para fijos

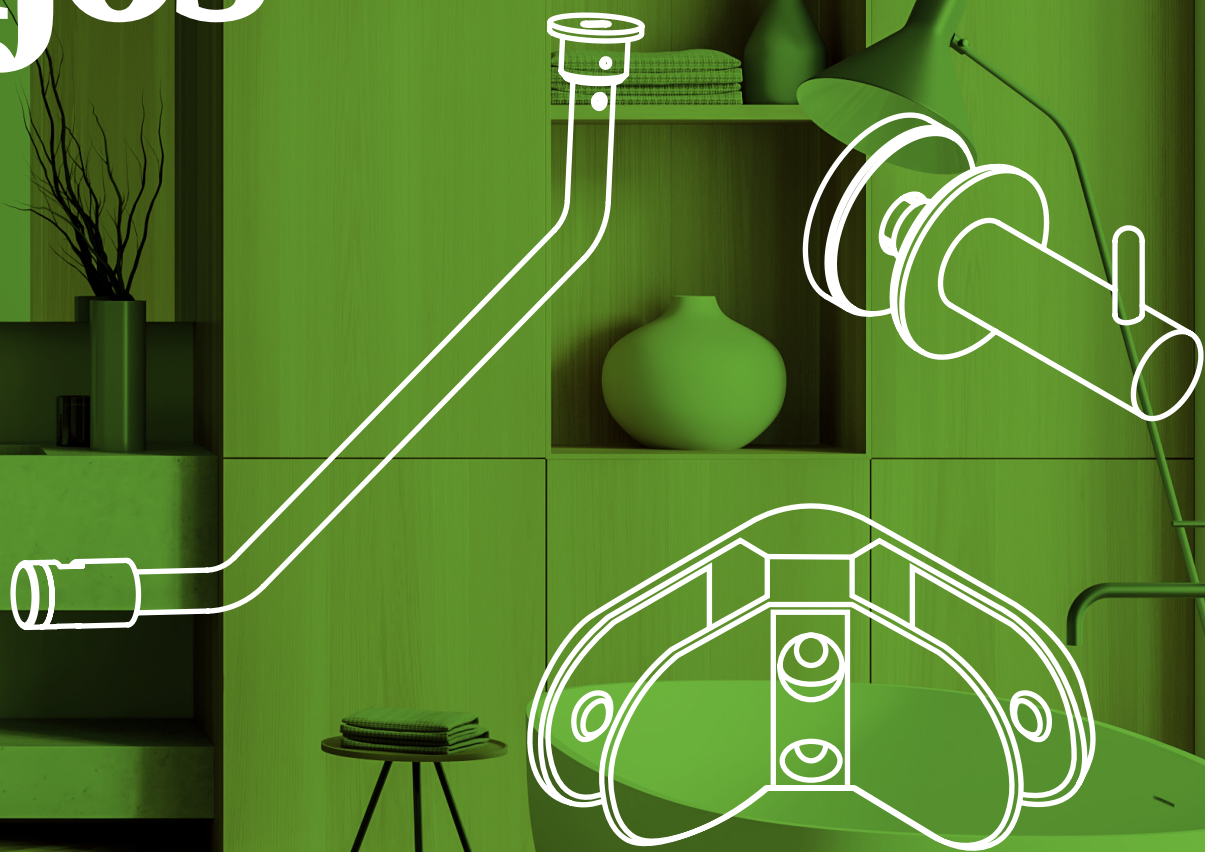

8.1 - KITS.....	484-487
8.2 - COMPONENTES.....	488-493
8.3 - PINZAS DE FIJACIÓN.....	494-499
8.4 - PERCHAS Y APOYOS PARA SUELO.....	500-501



8.1 - KITS

BARRA DE REFUERZO Y PINZAS PARA FIJOS

TUBO REDONDO AISI-304 Vidrio 6/8/10 mm

BARRA VIDRIO - PARED 90°

Tubo Ø 20 mm
Distancia: 250 mm

Acabados:

Inox brillo	1925 IB
Inox mate	1925 IM

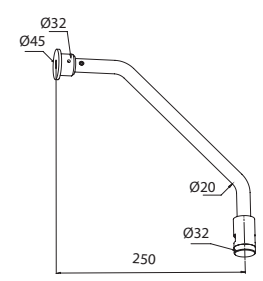

3030

BARRA VIDRIO - PARED

Tubo Ø 20 mm
Longitud: 1200 mm

Acabados:

Inox brillo	1925.2 IB
Inox mate	1925.2 IM

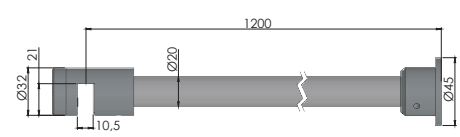
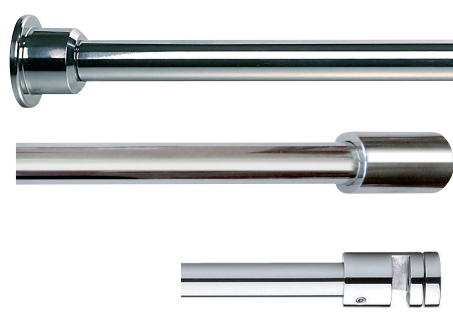

3031

BARRA VIDRIO - PARED EXTREMO ORIENTABLE

La barra se instala por encima del canto superior del vidrio, de modo que se libera espacio para el giro de la puerta hacia el interior.

Tubo Ø 20 mm
Longitud: 1200 mm

Acabados:

Inox brillo	1925.10 IB
Inox mate	1925.10 IM

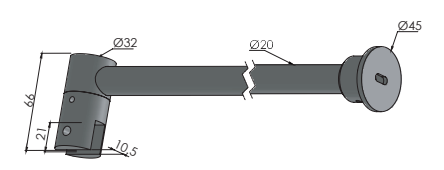

3051

BARRA TECHO - VIDRIO

Tubo Ø 20 mm
Longitud: 1200 mm

Acabados:

Inox brillo	1925.4 IB
Inox mate	1925.4 IM

Longitud: 500 mm

Acabados:

Inox brillo	1925.19 IB
Inox mate	1925.19 IM

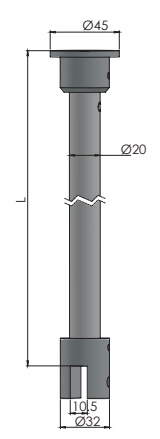

3032
3032S

BARRA EXTENSIBLE VIDRIO/PARED

Tubo \varnothing 25/20 mm
 Longitud: 640/1080 mm

Acabados:

Inox brillo	1925.12 IB
Inox mate	1925.12 IM

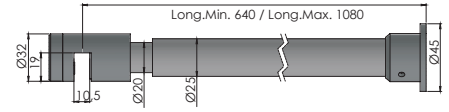
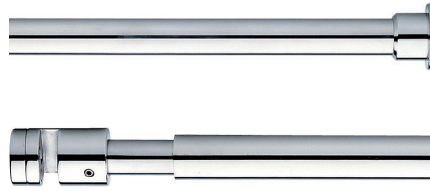

3035

BARRA ARTICULADA VIDRIO - PARED 90°

Tubo \varnothing 18 mm
 Distancia: 250 mm

Acabados:

Inox brillo	1925.17 IB
Inox mate	1925.17 IM

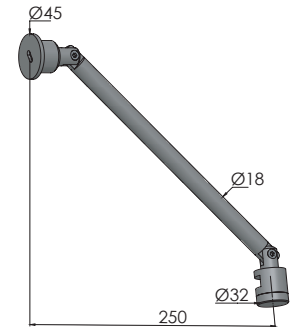

3040

LIGHT

AISI-304

Vidrio 8/10 mm

BARRA VIDRIO - PARED 90°

Tubo \varnothing 15 mm
 Distancia: 250 mm

Acabados:

Inox brillo	1925.30 IB
Inox mate	1925.30 IM

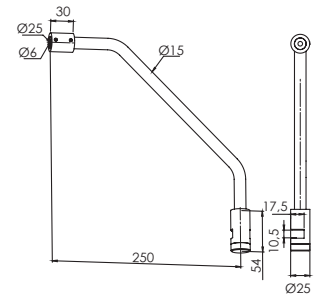

3030L

BARRA VIDRIO - PARED

Tubo \varnothing 15 mm
 Longitud: 1200 mm

Acabados:

Inox brillo	1925.32 IB
Inox mate	1925.32 IM

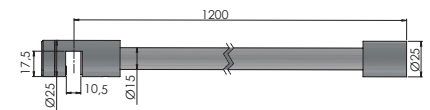
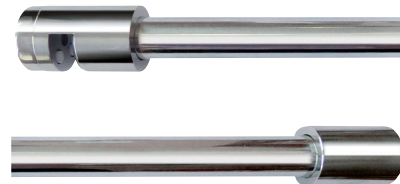

3035L

BARRA TECHO - VIDRIO

Tubo \varnothing 15 mm
 Longitud: 500 mm

Acabados:

Inox brillo	1925.34 IB
Inox mate	1925.34 IM

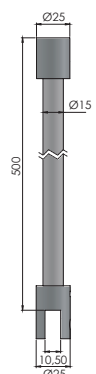

3032SL



TUBO CUADRADO

AISI-304

Vidrio 6/8/10 mm

BARRA VIDRIO - PARED

Tubo ∇ 20
Longitud: 1200 mm

Acabados:

Inox brillo	1925.14 IB
Inox mate	1925.14 IM

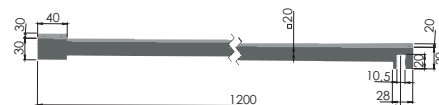

3050

BARRA VIDRIO - PARED

Libera espacio para el giro de la puerta hacia el interior

Tubo ∇ 20
Longitud: 1200 mm

Acabados:

Inox brillo	1925.15 IB
Inox mate	1925.15 IM

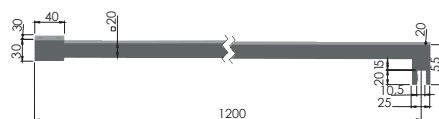
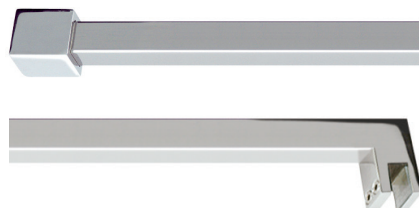

3053

BARRA TECHO - VIDRIO

Tubo ∇ 20
Longitud: 1200 mm

Acabados:

Inox brillo	1925.16 IB
Inox mate	1925.16 IM

Longitud: 500 mm

Acabados:

Inox brillo	1925.20 IB
Inox mate	1925.20 IM

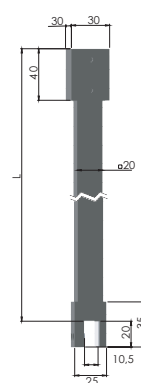
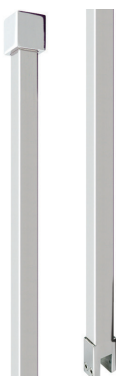

3054
3056

LIGHT

AISI-304

Vidrio 8/10 mm

BARRA VIDRIO - PARED

Tubo ∇ 15
Longitud: 1200 mm

Acabados:

Inox brillo	1925.50 IB
Inox mate	1925.50 IM

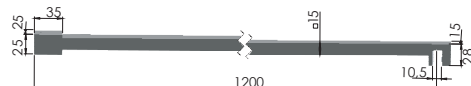

3050L

BARRA TECHO - VIDRIO

Tubo ∇ 15
Longitud: 500 mm

Acabados:

Inox brillo	1925.51 IB
Inox mate	1925.51 IM

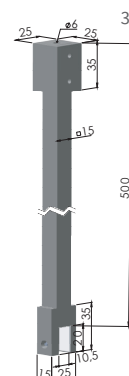

3054LS

AISI 304

Vidrio 6/10 mm

BARRA EXTENSIBLE VIDRIO/PARED 45°

De 270 a 450 mm

Acabados:

Inox brillo	5683.1 IB
Inox mate	5683.1 IM
Negro mate	5683.1 NE

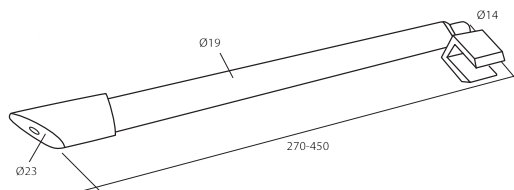
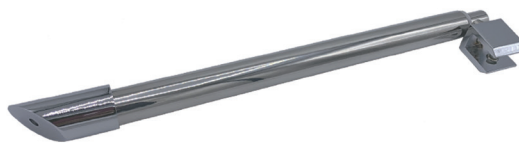

S3000

BARRA EXTENSIBLE VIDRIO/PARED 90°

De 300 a 340 mm

Acabados:

Inox brillo	5683.1 IB
Inox mate	5683.1 IM
Negro mate	5683.1 NE

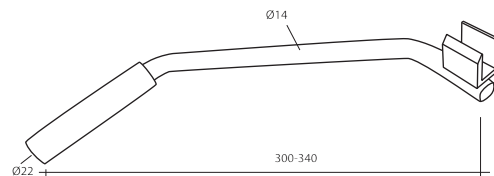

S3001

BARRA EXTENSIBLE VIDRIO/PARED

De 800 a 1000 mm

Acabados:

Inox brillo	5684.1 IB
Inox mate	5684.1 IM
Negro mate	5684.1 NE

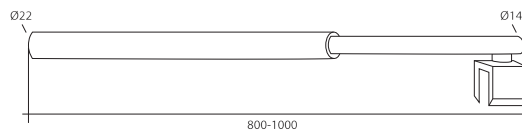

S3002

BARRA EXTENSIBLE VIDRIO/VIDRIO

De 800 a 1000 mm

Acabados:

Inox brillo	5684.1 IB
Inox mate	5684.1 IM
Negro mate	5684.1 NE

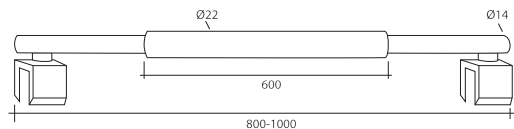

S3003

BARRA DE REFUERZO VIDRIO-PARED

Incluida en Kits Bañera y Ducha

Vidrio 6/8/10 mm

Acabados:

Plata brillo	2729 PB
Blanco	2729 BL





8.2 - COMPONENTES

BARRA DE REFUERZO Y PINZAS PARA FIJOS

TUBO REDONDO Ø 20 mm

Vidrio 8/10 mm

TUBO INOX Ø 20 mm

Acabados:

L. 300 mm	Inox brillo Inox mate Negro mate	5675 IB 5675 IM 5675 NE
L. 800 mm	Inox brillo Inox mate Negro mate	5675.1 IB 5675.1 IM 5675.1 NE
L. 1200 mm	Inox brillo Inox mate Negro mate	5675.2 IB 5675.2 IM 5675.2 NE

L. 1600 mm	Inox brillo Inox mate Negro mate	5675.3 IB 5675.3 IM 5675.3 NE
L. 2000 mm	Inox brillo Inox mate Negro mate	5675.4 IB 5675.4 IM 5675.4 NE

3031.23
3031.21
3031.2
3031.22
3031.24



EXTREMO PARED

Acabados:

Inox brillo	5676 IB
Inox mate	5676 IM

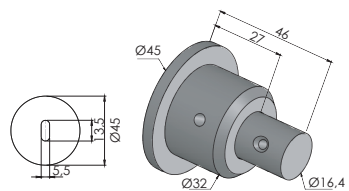

3030.1

EXTREMO PARED LONGITUDINAL

Acabados:

Inox brillo	5676.1 IB
Inox mate	5676.1 IM
Negro mate	5676.1 NE

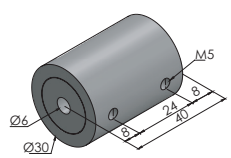

3049

EXTREMO PARED SALIDA A 135°

Acabados:

Inox brillo	5676.2 IB
Inox mate	5676.2 IM
Negro mate	5676.2 NE

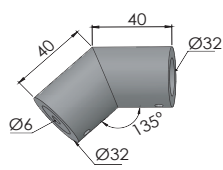

3031.11

EXTREMO FINAL VIDRIO

Acabados:

Inox brillo	5676.3 IB
Inox mate	5676.3 IM
Negro mate	5676.3 NE

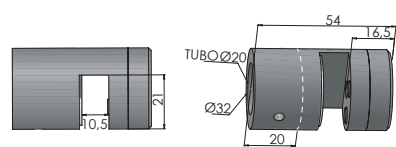

3031.3

EXTREMO FINAL VIDRIO

Taladro Ø 10 mm

Acabados:

Inox brillo	5676.4 IB
Inox mate	5676.4 IM
Negro mate	5676.4 NE

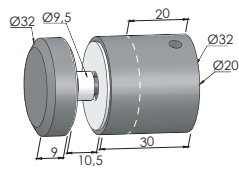

3031.4

EXTREMO FINAL VIDRIO ORIENTABLE

Acabados:

Inox brillo	5676.5 IB
Inox mate	5676.5 IM
Negro mate	5676.5 NE

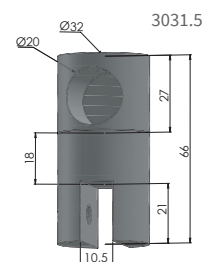

EXTREMO INTERMEDIO VIDRIO ORIENTABLE

Acabados:

Inox brillo	5676.6 IB
Inox mate	5676.6 IM
Negro mate	5676.6 NE

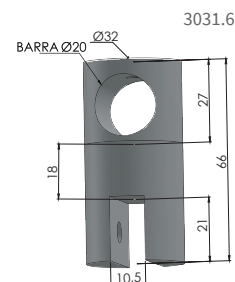

EXTREMO VIDRIO TECHO / VIDRIO

Acabados:

Inox brillo	5676.7 IB
Inox mate	5676.7 IM
Negro mate	5676.7 NE

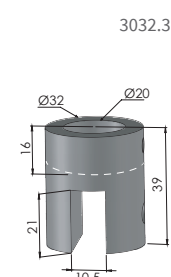

CONECTOR ESQUINA

Acabados:

Inox brillo	5676.8 IB
Inox mate	5676.8 IM
Negro mate	5676.8 NE

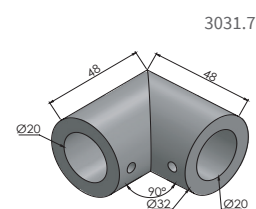

CONECTOR EN "T"

Acabados:

Inox brillo	5676.9 IB
Inox mate	5676.9 IM
Negro mate	5676.9 NE

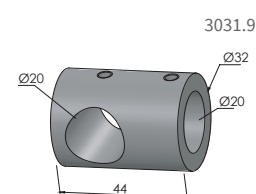

CONECTOR EN CRUZ

Acabados:

Inox brillo	5676.10 IB
Inox mate	5676.10 IM
Negro mate	5676.10 NE

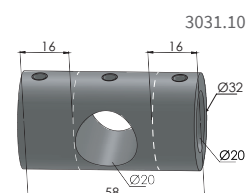

EXTREMO TECHO ARTICULADO

Para techos abuhardillados

Acabados:

Inox brillo	5676.11 IB
Inox mate	5676.11 IM

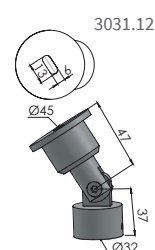



TUBO REDONDO Ø 15 mm

Vidrio 8/10 mm

TUBO INOX Ø 15 mm

Acabados:

L. 500 mm	Inox brillo Inox mate	5679 IB 5679 IM
L. 1000 mm	Inox brillo Inox mate	5679.1 IB 5679.1 IM



3031.21L
3031.22L

EXTREMO PARED LONGITUDINAL

Acabados:

Inox brillo	5679.5 IB
Inox mate	5679.5 IM

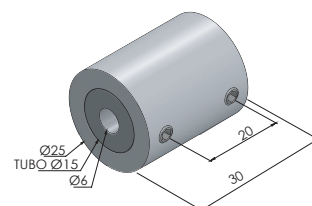

3049L

EXTREMO FINAL VIDRIO

Acabados:

Inox brillo	5679.6 IB
Inox mate	5679.6 IM

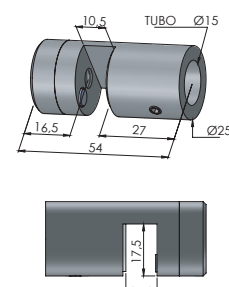

3031.3L

EXTREMO FINAL VIDRIO ORIENTABLE

Acabados:

Inox brillo	5679.7 IB
Inox mate	5679.7 IM

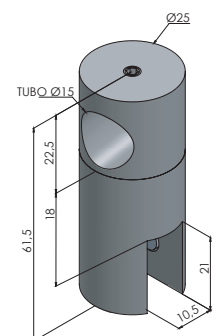

3031.5L

EXTREMO VIDRIO TECHO/VIDRIO

Acabados:

Inox brillo	5679.8 IB
Inox mate	5679.8 IM

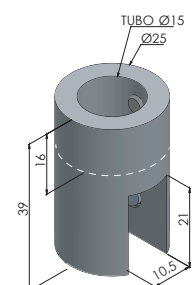

3032.3L

TUBO CUADRADO 20 mm

Vidrio 8/10 mm

TUBO INOX 20 mm

Acabados:

L. 300 mm	Inox brillo Inox mate Negro mate	5677 IB 5677 IM 5677 NE
L. 800 mm	Inox brillo Inox mate Negro mate	5677.1 IB 5677.1 IM 5677.1 NE
L. 1200 mm	Inox brillo Inox mate Negro mate	5677.2 IB 5677.2 IM 5677.2 NE

L. 1600 mm	Inox brillo Inox mate Negro mate	5677.3 IB 5677.3 IM 5677.3 NE
L. 2000 mm	Inox brillo Inox mate Negro mate	5677.4 IB 5677.4 IM 5677.4 NE

3050.50
3050.51
3050.52
3050.53
3050.54



EXTREMO PARED

Con pieza interior para instalaciones pared/pared

Acabados:

Inox brillo	5678 IB
Inox mate	5678 IM
Negro mate	5678 NE

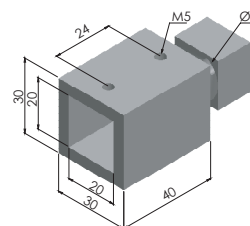

3050.3

EXTREMO PARED SALIDA A 135°

Acabados:

Inox brillo	5678.1 IB
Inox mate	5678.1 IM
Negro mate	5678.1 NE

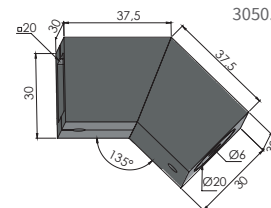

3050.2

EXTREMO FINAL VIDRIO

Acabados:

Inox brillo	5678.2 IB
Inox mate	5678.2 IM
Negro mate	5678.2 NE

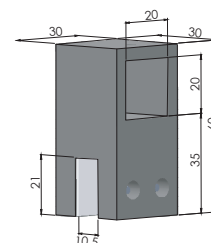

3050.5

EXTREMO INTERMEDIO VIDRIO

Acabados:

Inox brillo	5678.3 IB
Inox mate	5678.3 IM
Negro mate	5678.3 NE

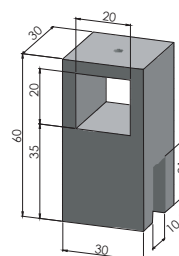

3050.6

EXTREMO FINAL VIDRIO 135°

Acabados:

Inox brillo	5678.4 IB
Inox mate	5678.4 IM
Negro mate	5678.4 NE

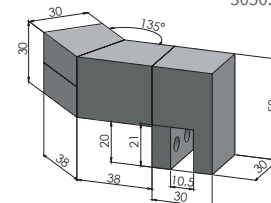
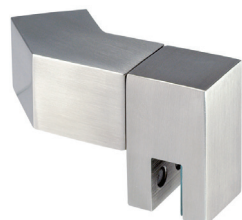

3050.7



CONECTOR ESQUINA

Acabados:

Inox brillo	5678.5 IB
Inox mate	5678.5 IM
Negro mate	5678.5 NE

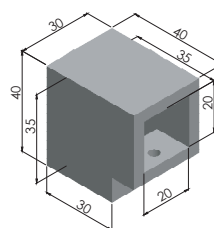

3050.10

EXTREMO PARED GIRATORIO

Acabados:

Inox brillo	5678.7 IB
Inox mate	5678.7 IM

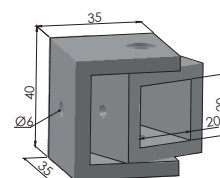

3050.11

EXTREMO INTERMEDIO VIDRIO EN PARALELO

Acabados:

Inox brillo	5678.8 IB
Inox mate	5678.8 IM
Negro mate	5678.8 NE

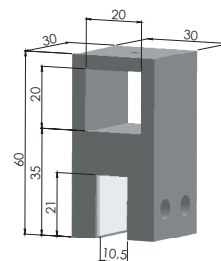

3050.8

EXTREMO INTERMEDIO VIDRIO GIRATORIO

Acabados:

Inox brillo	5678.9 IB
Inox mate	5678.9 IM
Negro mate	5678.9 NE

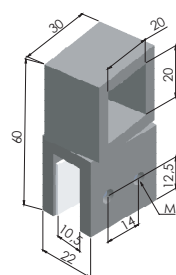

3050.9

EXTREMO VIDRIO TECHO / VIDRIO

Acabados:

Inox brillo	5678.10 IB
Inox mate	5678.10 IM
Negro mate	5678.10 NE

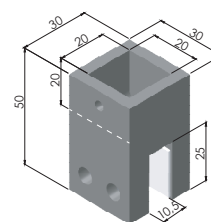

3050.4

CONECTOR EN "T"

Acabados:

Inox brillo	5678.11 IB
Inox mate	5678.11 IM
Negro mate	5678.11 NE



3050.12

TUBO REDONDO Ø 22 mm

Vidrio 6/8/10 mm

TUBO INOX Ø 22 mm

Inox brillo

Acabados:

L. 500 mm	5680 IB
L. 1000 mm	5680.1 IB
L. 1500 mm	5680.2 IB
L. 2000 mm	5680.3 IB
L. 3000 mm	5680.4 IB



S 2050
S 2100
S 2150
S 2200
S 2300

SOPORTE PARED

S 1000

Acabados:

Plata brillo	5681.1 PB
--------------	------------------

A	B	C
Ø 22	Ø 38	39

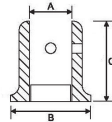

SOPORTE VIDRIO

S 1001

Acabados:

Plata brillo	5681.2 PB
--------------	------------------

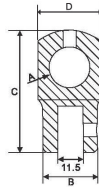

A	B	C	D
Ø 22	Ø 28	61	32

SOPORTE VIDRIO CIEGO

S 1002

Acabados:

Plata brillo	5681.3 PB
--------------	------------------

A	B	C	D
Ø 22	Ø 28	63	32

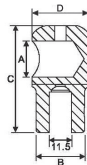

SOPORTE VIDRIO CIEGO CON TOPE

S 1003

Acabados:

Plata brillo	5681.4 PB
--------------	------------------

A	B	C	D
Ø 22	Ø 28	63	32

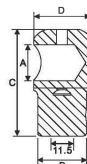

SOPORTE PARED 45°

S 1006

Acabados:

Plata brillo	5682.2 PB
--------------	------------------

A	B	C
Ø 22	Ø 30	65

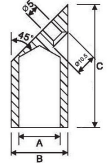

SOPORTE MANGUITO

S 1007

Acabados:

Plata brillo	5682.3 PB
--------------	------------------

A	B	C
Ø 22	Ø 30	60

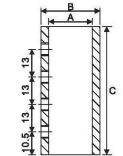

SOPORTE ÁNGULO 90°

S 1008

Acabados:

Plata brillo	5682.4 PB
--------------	------------------

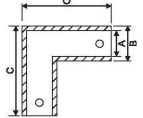

SOPORTE ÁNGULO 135°

Acabados:

Plata brillo	5682.5 PB
--------------	------------------

A	B	C
Ø 22	Ø 32	60

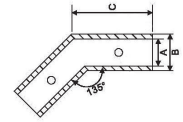

SOPORTE VIDRIO FIJO

S 1010

Acabados:

Plata brillo	5682.6 PB
--------------	------------------

A	B
Ø 22	Ø 28

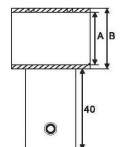

SOPORTE CIEGO

S 1005

Acabados:

Plata brillo	5682.1 PB
--------------	------------------

A	B	C
Ø 22	Ø 30	60

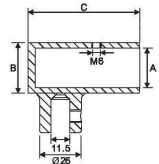



8.3 - PINZAS DE FIJACIÓN



BARRA DE REFUERZO Y PINZAS PARA FIJOS

PINZAS DE FIJACIÓN

AISI-316

PINZA SIN TOPE FIJACIÓN SUPERIOR

60 x 50 x 22 mm

Acabados:

V. 8 mm	Inox brillo Inox mate	1121 IB 1121 IM
V. 10 mm	Inox brillo Inox mate	1121.1 IB 1121.1 IM
V. 12 mm	Inox brillo Inox mate	1121.2 IB 1121.2 IM
V. 16 mm	Inox brillo Inox mate	1121.3 IB 1121.3 IM
V. 20 mm	Inox brillo Inox mate	1121.4 IB 1121.4 IM

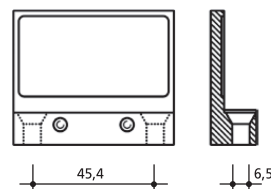

3212S
3225S
3288S
3289S
3290S

* Grosor especial bajo pedido

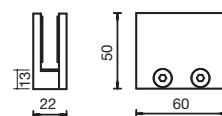

PINZA CON TOPE FIJACIÓN SUPERIOR

60 x 50 x 22 mm

Acabados:

V. 8 mm	Inox brillo Inox mate	1122 IB 1122 IM
V. 10 mm	Inox brillo Inox mate	1122.1 IB 1122.1 IM
V. 12 mm	Inox brillo Inox mate	1122.2 IB 1122.2 IM
V. 16 mm	Inox brillo Inox mate	1122.3 IB 1122.3 IM
V. 20 mm	Inox brillo Inox mate	1122.4 IB 1122.4 IM

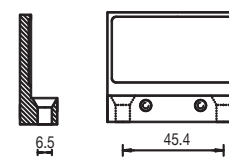

3213S
3227S
3288ST
3289ST
3290ST

* Indicar mano

* Grosor especial bajo pedido

PINZA SIN TOPE FIJACIÓN FRONTAL

60 x 50 x 22 mm

Acabados:

V. 8 mm	Inox brillo Inox mate	1123 IB 1123 IM
V. 10 mm	Inox brillo Inox mate	1123.1 IB 1123.1 IM

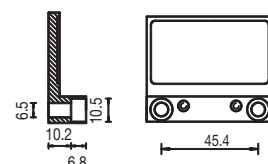

3212F
3225F

* Grosor especial bajo pedido

PINZA CON TOPE FIJACIÓN FRONTAL

60 x 50 x 22 mm

Acabados:

V. 8 mm	Inox brillo Inox mate	1124 IB 1124 IM
V. 10 mm	Inox brillo Inox mate	1124.1 IB 1124.1 IM

* Indicar mano

* Grosor especial bajo pedido

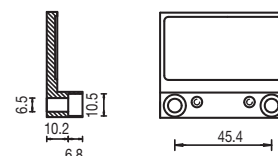

3221F
3228F
3213F
3227F

PINZA DOBLE SIN TOPE

88 x 60 x 22 mm

Distancia entre vidrios 14 mm

Acabados:

V. 8 mm	Inox brillo Inox mate	1125 IB 1125 IM
V. 10 mm	Inox brillo Inox mate	1125.1 IB 1125.1 IM
V. 12 mm	Inox brillo Inox mate	1125.2 IB 1125.2 IM
V. 16 mm	Inox brillo Inox mate	1125.3 IB 1125.3 IM
V. 20 mm	Inox brillo Inox mate	1125.4 IB 1125.4 IM

* Grosor especial bajo pedido

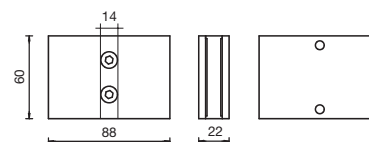

3214
3229
3410
3411
3412

PINZA DOBLE CON TOPE

88 x 60 x 22 mm

Distancia entre vidrios 14 mm

Acabados:

V. 8 mm	Inox brillo Inox mate	1126 IB 1126 IM
V. 10 mm	Inox brillo Inox mate	1126.1 IB 1126.1 IM
V. 12 mm	Inox brillo Inox mate	1126.2 IB 1126.2 IM
V. 16 mm	Inox brillo Inox mate	1126.3 IB 1126.3 IM
V. 20 mm	Inox brillo Inox mate	1126.4 IB 1126.4 IM

* Grosor especial bajo pedido

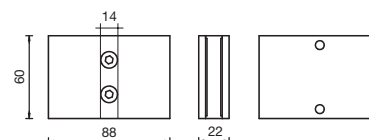

3214T
3229T
3410T
3411T
3412T



8.3 - PINZAS DE FIJACIÓN



BARRA DE REFUERZO Y PINZAS PARA FIJOS
PINZAS DE FIJACIÓN

AISI-316

PINZA DOBLE ESQUINA 90° SIN TOPE

Acabados:

V. 8 mm	Inox brillo Inox mate	1129 IB 1129 IM
V. 10 mm	Inox brillo Inox mate	1129.1 IB 1129.1 IM

* Grosor especial bajo pedido



Sin fijación a montante

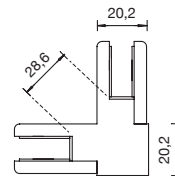

3237
3238

PINZA DOBLE ESQUINA 90° CON TOPE

Acabados:

V. 8 mm	Inox brillo Inox mate	1130 IB 1130 IM
V. 10 mm	Inox brillo Inox mate	1130.1 IB 1130.1 IM

* Grosor especial bajo pedido



Sin fijación a montante

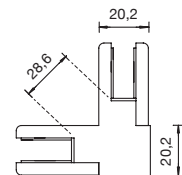

3237T
3238T

8.3 - PINZAS DE FIJACIÓN



AISI-316

PINZA DOBLE ESQUINA 90° **NOVEDAD**

Acabados:

Inox mate	4905 IM
-----------	----------------

Juntas para 12,76 mm	4905.12
Juntas para 16,76 mm	4905.16

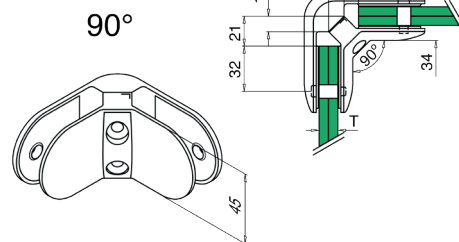

142890-13-12
205028-13
205028-17

PINZA DOBLE ESQUINA 90° **NOVEDAD**

Acabados:

Inox mate	4906 IM
-----------	----------------

Juntas para 12,76 mm	4906.12
Juntas para 16,76 mm	4906.16

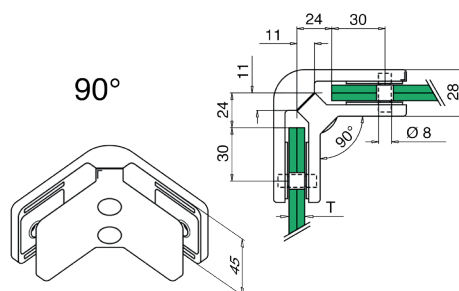

144290-13-12
205042-13
205042-17

INOX AISI-316

PINZA SIN MUESCA

45 x 45 mm

Acabados:

Inox brillo	1725.1B
Inox mate	1725.1M

Elegir las gomas para el grosor que se quiera.

Juntas para 8 mm	1725.8
Juntas para 10 mm	1725.10
Juntas para 12 mm	1725.12

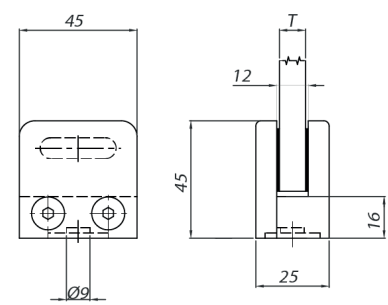
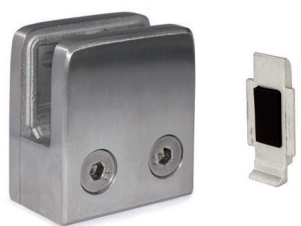

PINZA SIN MUESCA

45 x 45 mm

Base curva para tubo Ø 42,4 mm

Acabados:

Inox brillo	1725.1B
Inox mate	1725.1M

Elegir las gomas para el grosor que se quiera.

Juntas para 8 mm	1725.8
Juntas para 10 mm	1725.10
Juntas para 12 mm	1725.12

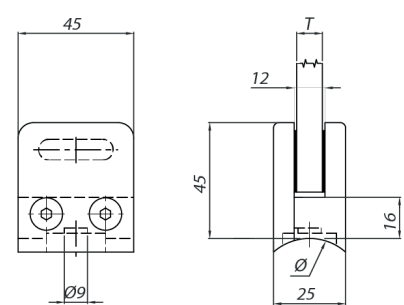

PINZA SIN MUESCA

50 x 40 mm

Vidrio 8/10 mm

Acabados:

Inox brillo	1726.1B
Inox mate	1726.1M

Elegir las gomas para el grosor que se quiera.

Juntas para 8 mm	1726.8
Juntas para 10 mm	1726.10

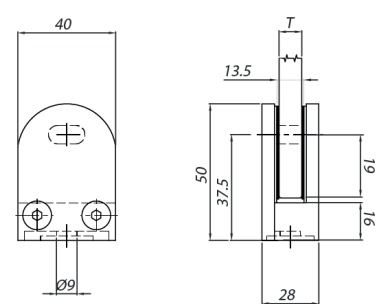

PINZA SIN MUESCA

50 x 40 mm

Base curva para tubo Ø 42,4 mm

Vidrio 8/10 mm

Acabados:

Inox brillo	1726.1B
Inox mate	1726.1M

Elegir las gomas para el grosor que se quiera.

Juntas para 8 mm	1726.8
Juntas para 10 mm	1726.10

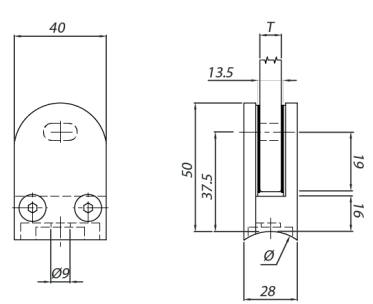



AISI-316

PINZA DE BARANDILLA 70 x 55 mm

Taladro opcional Ø 8 mm

Acabados:

Inox brillo	1729 IB
Inox mate	1729 IM

Elegir las gomas para el grosor que se quiera.

Juntas para 12,76 mm	1729.12
Juntas para 16,76 mm	1729.16



X21300000
E21300000

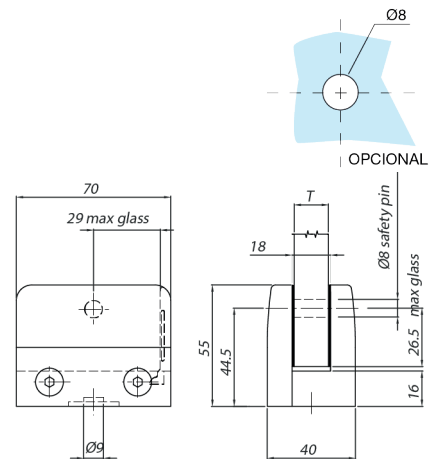

PINZA DE BARANDILLA 70 x 55 mm

Base curva para tubo 0 48,3mm

Taladro opcional Ø 8 mm

Acabados:

Inox brillo	1729.1 IB
Inox mate	1729.1 IM

Elegir las gomas para el grosor que se quiera.

Juntas para 12,76 mm	1729.12
Juntas para 16,76 mm	1729.16



X21304800
E21304800

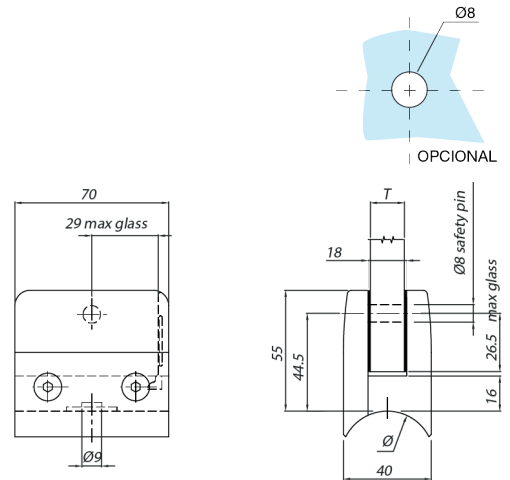

PIEZAS BAJO PEDIDO



PINZA HUECA ECO SIN MUESCA

59 x 43 mm

Vidrio 8 a 12,76 mm

Taladro opcional al vidrio Ø 8 mm

Material: Inox AISI-316

Acabados:

Inox brillo	1727 IB
Inox mate	1727 IM

*Para ancho máximo de vidrio 800 mm.

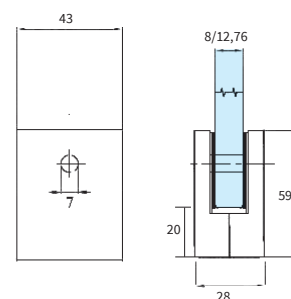

PINZA HUECA ECO SIN MUESCA

54 x 43 mm

Vidrio 8 a 12,76 mm

Taladro opcional al vidrio Ø 8 mm

Material: Inox AISI-316

Acabados:

Inox brillo	1728 IB
Inox mate	1728 IM

*Para ancho máximo de vidrio 800 mm.

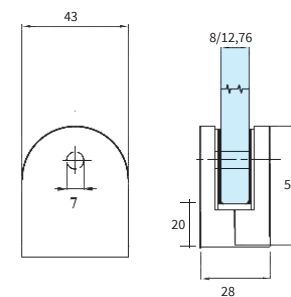

PINZA DE FIJACIÓN MAMPARA BAÑO

45 x 45 mm

Vidrio 8/10 mm

Material: latón

Acabado:

Plata brillo	1886.I PB
--------------	------------------

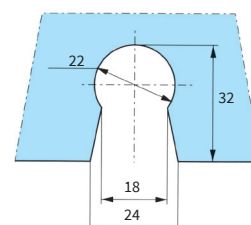
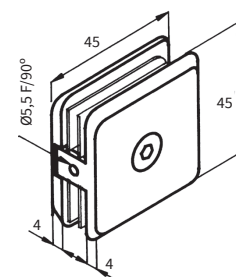
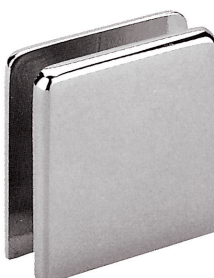



8.4 - PERCHAS Y APOYOS PARA SUELO



PERCHA

Para pegar con UVA

Acabados:

Inox brillo	1090 IB
Inox mate	1090 IM

Para vidrio 8/10 mm,
taladro Ø 12 mm

Acabados:

Inox brillo	1091 IB
Inox mate	1091 IM

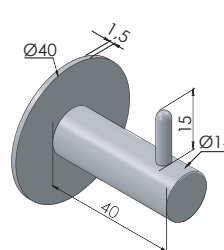
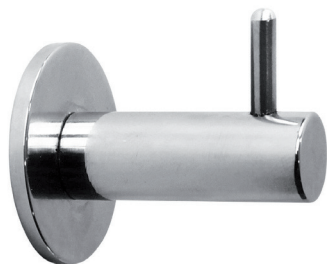

Ref. 1090

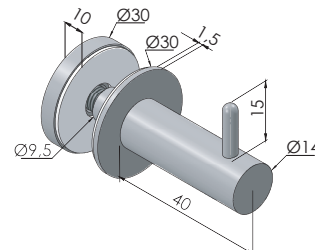

Ref. 1091

3090
3091

PERCHA Q

Para pegar con UVA

Acabados:

Inox brillo	1098 IB
Inox mate	1098 IM

Para vidrio 8/10 mm,
taladro Ø 12 mm

Acabados:

Inox brillo	1099 IB
Inox mate	1099 IM

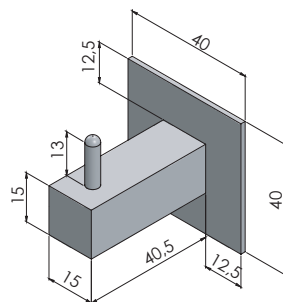

Ref. 1098

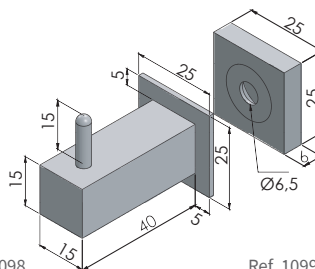

Ref. 1099

3092
3093

APOYO SUELO

Vidrio 8/10 mm

Altura suelo/vidrio: 150 mm

Tubo Ø 20 mm para cortar
a medida

Acabados:

Inox brillo	1092 IB
Inox mate	1092 IM

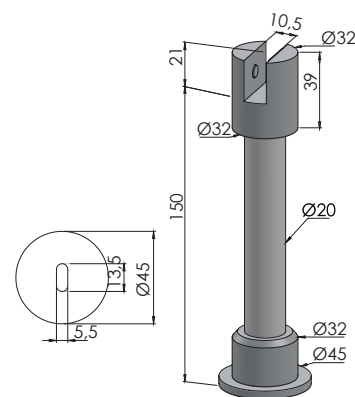

3057

APOYO SUELO REGULABLE

Vidrio 8/10 mm

Altura regulable de 75 a 105 mm

sin cortar el tubo

Acabados:

Inox brillo	1093 IB
Inox mate	1093 IM

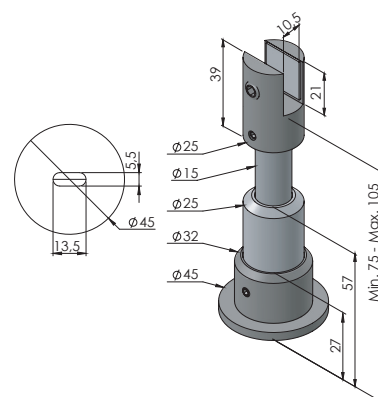

3058

APOYO SUELO Q

Vidrio 8/10 mm
 Altura suelo/vidrio: 150 mm
 Tubo 20 x 20 mm para cortar a medida

Acabados:

Inox brillo	1094 IB
Inox mate	1094 IM

3059

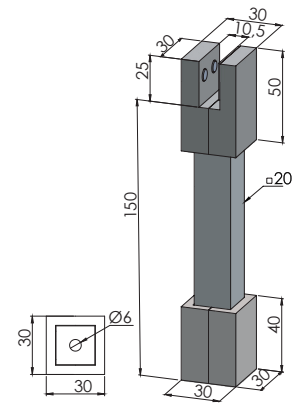

PIE CON PLETINA + PINZA

Vidrio 8/10 mm
 AISI-304

Acabados:

H=60 mm $\nabla = 12$ mm	Inox brillo Inox mate	1920.4 IB 1920.4 IM
H=80 mm $\nabla = 12$ mm	Inox brillo Inox mate	1920.5 IB 1920.5 IM
H=100 mm $\nabla = 12$ mm	Inox brillo Inox mate	1920.6 IB 1920.6 IM

* Grosor especial bajo pedido
 * Con tope bajo pedido

3209
 3210
 3211

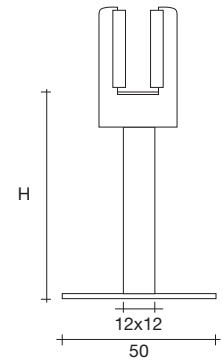

PIE CON PLETINA + PINZA

Vidrio 8/10 mm
 AISI-304

Base ciega

Acabados:

H=60 mm $\nabla = 12$ mm	Inox brillo Inox mate	1920.44 IB 1920.44 IM
H=80 mm $\nabla = 12$ mm	Inox brillo Inox mate	1920.45 IB 1920.45 IM
H=100 mm $\nabla = 12$ mm	Inox brillo Inox mate	1920.46 IB 1920.46 IM

* Grosor especial bajo pedido
 * Con tope bajo pedido

3209C
 3210C
 3211C

